



Bazuka 3 Wire Track Spot Light

15W

Applications:

Residential and Commercial Applications.

- **Dynamic Dual Heat Sink** ensuring longevity and the reduction in lumen depreciation.
- **High Lumen COB LED** coupled with a high-performance lens delivering an effective 100lm/W.
- **Elegant**, sophisticated look bringing style to your application.
- **340° rotation** allowing for precise aiming.
- **3 Wire system** for use in all single-phase circuits.
- **Deep reflector (36°)** helps in the reduction of glare whilst not impacting lumen output.
- Matt black or chique white trendy powder coated finish.
- **3kV built in surge protection** designed to withstand the toughest environments.
- **High spec driver** with a high PF>0.9 – ideal for retail/commercial industries.

Product Performance

Wattage	15W
Colour Temperature & Stock Code	• 3000K/4000K/6000K (3CCT) - TKB098
Operating Temperature	-15~45°C
Life Span/ LB Rating	L80B10@50 000hr
IP Rating	IP20
LED Driver	High Spec PioLED Driver
Beam Angle	36°
Impact Protection Grade	IK05
Input Voltage	200V-277V
Surge Protection	3kV
Power Factor	0.9
CRI	>83
Lumen Output	1 500 Lumens
Lumen Efficiency	100
LED Chips	Bridgelux COB
LED Chips Qty	1
Dimmable	Dimmable with optional 15W Bazuka Dim Driver - Slim 3WiB - TKB098D
UGR	19
Physical Characteristics	
Weight (g)	320
Housing Material	Aluminium
Product Dimensions (mm)	60*134
Cable Length	-
Mounting Option	3 Wire Track
Bracket Material	-
Bolts and Screws	Iron with nickel plating

Packaging



Luminous Intensity Distribution Diagram

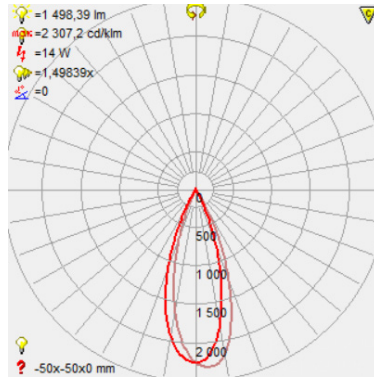

Dimension Drawing

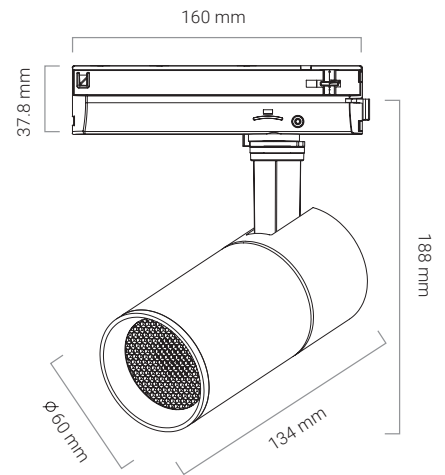

Technical Parameters

Input Current	0.07A
Flicker Free (Y/N)	Yes
Output Voltage	25-42 V
Humidity	20-80%
Frequency	50-60Hz
In Rush Current	0.5A
Output Current	0.35A
THD	<20%
TA & TC	45/85°C
IES (Yes or No)	Yes
Regulatory Qualifications	
Class Rating	Class II
Energy Efficiency	A
Certification	CE, EMC, IEC60598
Accessories	
Optional accessories	List on accessory page
Packaging info	
Storage Temp	-20~50°C
Carton Size (mm)	350*280*395
QTY/CTN	12
Net Weight	5
Gross Weight	6



**PIOLED
LIGHTING**
SINCE 2008

BAZUKA, SNYPA & LEDA

ACCESSORIES



Multi Angle Connector 3
Wire Black or White

Black **TKB121**
White **TKW121**



1, 2 or 3 metre 3 Wire Track Set
(including Power Feed & End Cap)
Black or White

1M Black **TKB110**
1M White **TKW110**
2M Black **TKB111**
2M White **TKW111**
3M Black **TKB112**
3M White **TKW112**

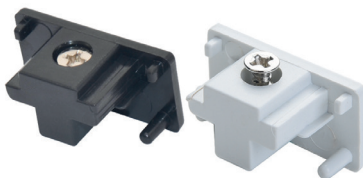

End cap 3 Wire
Black or White

Black **TKB119**
White **TKW119**



Track adapter 3 Wire
Black or White

Black **TKB120**
White **TKW120**



I-Connector 3 Wire
Black or White

Black **TKB114**
White **TKW114**



Power Feed 3 Wire
Black or White

Black **TKB113**
White **TKW113**

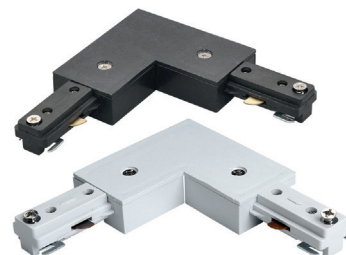

L-Connector 3 Wire
Black or White

Black **TKB116**
White **TKW116**

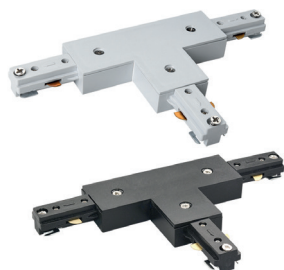

T-Connector 3 Wire
Black or White

Black **TKB117**
White **TKW117**

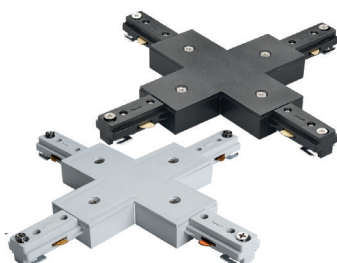

X-Connector 3 Wire
Black or White

Black **TKB118**
White **TKW118**

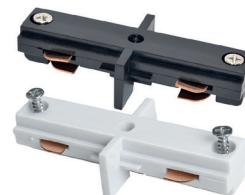

Slim I-Connector 3 Wire
Black or White

Black **TKB115**
White **TKW115**