



# Bazuka 3 Wire Track Spot Light

## 25W

### Applications:

Residential and Commercial Applications.

- **Dynamic Dual Heat Sink** ensuring longevity and the reduction in lumen depreciation.
- **High Lumen COB LED** coupled with a high-performance lens delivering an effective 100lm/W.
- **Elegant**, sophisticated look bringing style to your application.
- **340° rotation** allowing for precise aiming.
- **3 Wire system** for use in all single-phase circuits.
- **Deep reflector (36°)** helps in the reduction of glare whilst not impacting lumen output.
- Matt black or chique white trendy powder coated finish.
- **3kV built in surge protection** designed to withstand the toughest environments.
- **High spec driver** with a high PF>0.9 – ideal for retail/commercial industries.

### Product Performance

<b>Wattage</b>	25W
<b>Colour Temperature &amp; Stock Code</b>	• 3000K/4000K/6000K (3CCT) - <b>TKB099</b>
<b>Operating Temperature</b>	-15~45°C
<b>Life Span/ LB Rating</b>	L80B10@50 000hr
<b>IP Rating</b>	IP20
<b>LED Driver</b>	High Spec PioLED Driver
<b>Beam Angle</b>	36°
<b>Impact Protection Grade</b>	IK05
<b>Input Voltage</b>	200V-277V
<b>Surge Protection</b>	3kV
<b>Power Factor</b>	0.9
<b>CRI</b>	>83
<b>Lumen Output</b>	2 500 Lumens
<b>Lumen Efficiency</b>	100
<b>LED Chips</b>	Bridgelux COB
<b>LED Chips Qty</b>	1
<b>Dimmable</b>	Dimmable with optional 25W Bazuka Dim Driver - Slim 3WiB - TKB099D
<b>UGR</b>	19
<b>Physical Characteristics</b>	
<b>Weight (g)</b>	460
<b>Housing Material</b>	Aluminium
<b>Product Dimensions (mm)</b>	75*142
<b>Cable Length</b>	-
<b>Mounting Option</b>	3 Wire Track
<b>Bracket Material</b>	-
<b>Bolts and Screws</b>	Iron with nickel plating

## Packaging



## Luminous Intensity Distribution Diagram

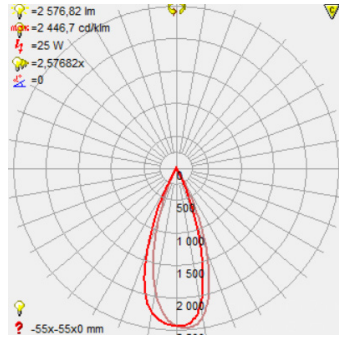

## Dimension Drawing

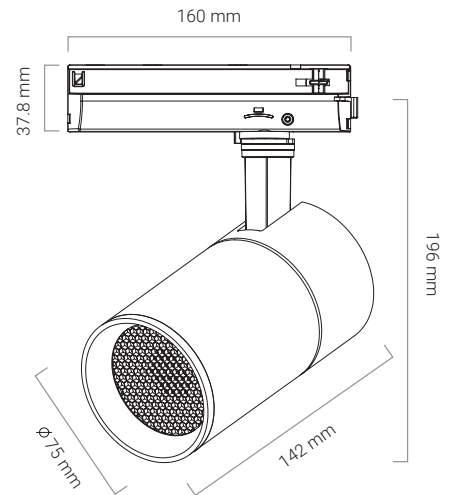

## Technical Parameters

<b>Input Current</b>	0.12A
<b>Flicker Free (Y/N)</b>	Yes
<b>Output Voltage</b>	25-42 V
<b>Humidity</b>	20-80%
<b>Frequency</b>	50-60Hz
<b>In Rush Current</b>	0.8A
<b>Output Current</b>	0.6A
<b>THD</b>	<20%
<b>TA &amp; TC</b>	45/85°C
<b>IES (Yes or No)</b>	Yes
<b>Regulatory Qualifications</b>	
<b>Class Rating</b>	Class II
<b>Energy Efficiency</b>	A
<b>Certification</b>	CE, EMC, IEC60598
<b>Accessories</b>	
<b>Optional accessories</b>	List on accessory page
<b>Packaging info</b>	
<b>Storage Temp</b>	-20~50°C
<b>Carton Size (mm)</b>	380*325*425
<b>QTY/CTN</b>	12
<b>Net Weight</b>	6
<b>Gross Weight</b>	7



**PIOLED  
LIGHTING**  
SINCE 2008

# BAZUKA, SNYPA & LEDA

## ACCESSORIES



Multi Angle Connector 3  
Wire Black or White

Black **TKB121**  
White **TKW121**



1, 2 or 3 metre 3 Wire Track Set  
(including Power Feed & End Cap)  
Black or White

1M Black **TKB110**  
1M White **TKW110**  
2M Black **TKB111**  
2M White **TKW111**  
3M Black **TKB112**  
3M White **TKW112**

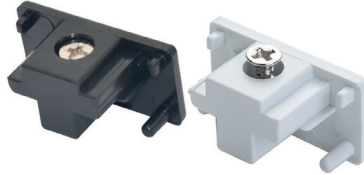

End cap 3 Wire  
Black or White

Black **TKB119**  
White **TKW119**



Track adapter 3 Wire  
Black or White

Black **TKB120**  
White **TKW120**



I-Connector 3 Wire  
Black or White

Black **TKB114**  
White **TKW114**



Power Feed 3 Wire  
Black or White

Black **TKB113**  
White **TKW113**

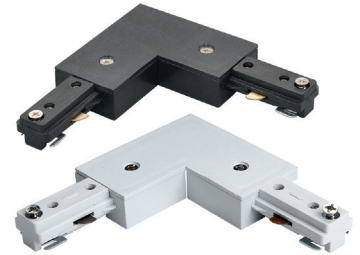

L-Connector 3 Wire  
Black or White

Black **TKB116**  
White **TKW116**

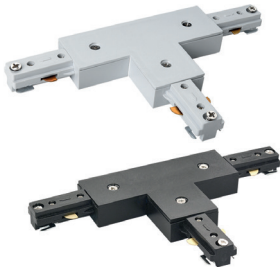

T-Connector 3 Wire  
Black or White

Black **TKB117**  
White **TKW117**

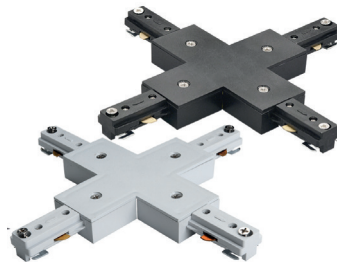

X-Connector 3 Wire  
Black or White

Black **TKB118**  
White **TKW118**

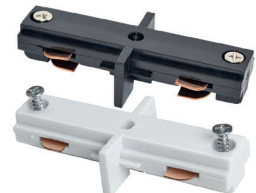

Slim I-Connector 3 Wire  
Black or White

Black **TKB115**  
White **TKW115**